

May 2013

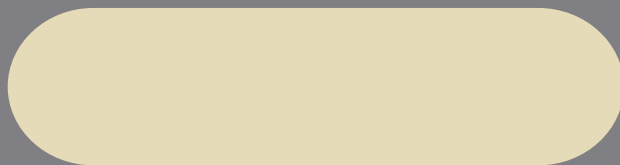

PREFACE

This document is intended to provide a general understanding of HPL, its manufacture, properties, types and relevant international standards.

It provides information on working methods with Thin HPL, as well as some good practice recommendations for its use.

The advice and recommendations have an advisory nature only.

If you need more information or have a specific question, please contact Arpa customer service.

1 — AN INTRODUCTION TO HPL

1.1 What is HPL

Decorative High Pressure Laminates (HPL), as defined by the European and international standards for HPL, EN 438 and ISO 4586, are high-density panels ($\geq 1.35\text{g/cm}^3$), finished and ready for use, which have exceptional mechanical, physical strength and chemical resistance, are easy to work and simple to maintain.

Arpa HPL panels are made of several layers of cellulose fibre material impregnated with thermosetting resins and then simultaneously subjected to both pressure ($>7\text{MPa}$) and heat ($140 / 150^\circ\text{C}$) in special presses, for a fixed time, which varies depending on the type of laminate.

This process creates a stable, inert, homogeneous, non-porous and high density material, with physical and chemical properties that are totally different from those of its original ingredients. In addition, given its very low permeability, HPL acts as a barrier against the possible emission of formaldehyde and other volatile substances (VOCs) from any timber substrates it is applied to.

1.2 Composition

HPL panels are made exclusively of cellulose-based materials (60-70%) and thermosetting resins (30-40%). They can have decorative finishes on one or both sides.

These are the different layers:

- **Overlay**
A highly transparent paper, which makes the laminate surface abrasion and scratch resistant. Used only with printed patterns.
- **Decorative paper**
External paper, with no chlorides.
These are coloured or patterned and give the laminate its aesthetic appearance.
- **Kraft paper**
“The heart” of HPL. This is the, mostly brown, paper, which is the core of high-pressure laminate.

1.3 The history of HPL

The history of Decorative High Pressure Laminate (HPL) began back in 1896, when Leo Baekeland, an American chemist of Belgian origin, combined phenol and formaldehyde to obtain a resin product that could be converted into an insoluble polymer.

By adding a fine sawdust filler, he obtained a very dark coloured plastic material which he patented in 1907 under the name of Bakelite, from his own surname. The “precursor” of today’s HPL was born.

This was a material with excellent mechanical and, above all, electrically non-conductive properties, which immediately attracted the interest of the electrical industry, replacing porcelain and mica as the insulating material in electrical devices.

It was later used in many other areas, from acoustic, electrical or thermal insulation to agriculture and from textiles to aviation. However, the poor lightfastness of phenol-formaldehyde resins did not permit a wide range of colours; these early laminates could only be in black or brown.

Other discoveries appeared but only on the horizon. As early as 1906, Leibich was focusing his research on the reactions of melamine-formaldehyde. It was discovered that these resins, mixed with cellulose and subjected to a polymerisation process, produced a solid material with excellent mechanical properties, stable to light and abrasion resistant and electrically non-conductive. Then in the ‘40s, the development of decorative papers that were highly absorbent of melamine-formaldehyde made it possible to pay attention to the appearance of the panels by giving them a more varied and attractive finish.

Modern HPL decorative laminate was born, produced for the first time in the United States.

In the ‘50s, this new material gained enormous success, due to both its aesthetic and its functional values. The intrinsic properties of this revolutionary material and the obvious advantages it offered as a surface covering, enabled it to take the place of paints, lacquers, wood veneers, wallpaper etc.

Initial success was typically seen in kitchen furniture, modular “American style” kitchens, tables, shelving, restaurant counters and everywhere that food was handled.

In the decades that followed, research, innovation and development work for new types of HPL opened the way for countless potential applications in many different market sectors and generated a wide range of product types, from cigarette-proof HPL in the ‘60s to one with self-supporting properties, from flame spread resistant laminate to the post-forming variety for the furniture industry, from compact to integral varieties and metals.

1.4 Fields of application

Today, thanks to its particular properties, HPL is widely used in miscellaneous fields.

Its excellent mechanical and physical performance and toughness make high-pressure laminate one of the most popular materials in interior design, from wall cladding to flooring and from suspended ceilings to furnishing accessories and furniture.

In particular, due to its hygienic qualities and ease of maintenance, it has always been widely used in kitchens and everywhere that requires special attention to hygiene, such as hospitals, laboratories, restaurants etc.

Arpa offers materials and solutions for many applications (see table). Some collections, such as Arpa for Kitchen and Arpa for Retail & Contract have been specially designed to respond to the specific requirements for particular purposes.

Applications

Walls
Partitions
Ceilings
Doors

Floors
Staircases
Furniture
Chairs

Tables
Worktops
Counters
Bathrooms

Showers
Bookcases
Display units
Shopfitting

Market Sectors

Design Furniture



Lifts



Marine



Education



Office



Healthcare & Wellness



Hospitality & Restaurants



Transport



Retail & Contract



Kitchen



Street Furniture



2 — MANUFACTURE

2.1 Manufacturing process

Behind the apparent simplicity of high pressure laminates lies highly advanced technology that requires a powerful manufacturing plant and substantial investment in research and development.

The manufacturing process for HPL is governed by EN 438 and ISO 4586, which sets out specifications for the finished product.

In Arpa specifically, the decorative and kraft papers are mainly purchased from paper mills, while the thermosetting resins are produced in-house.

These are the different manufacturing stages:

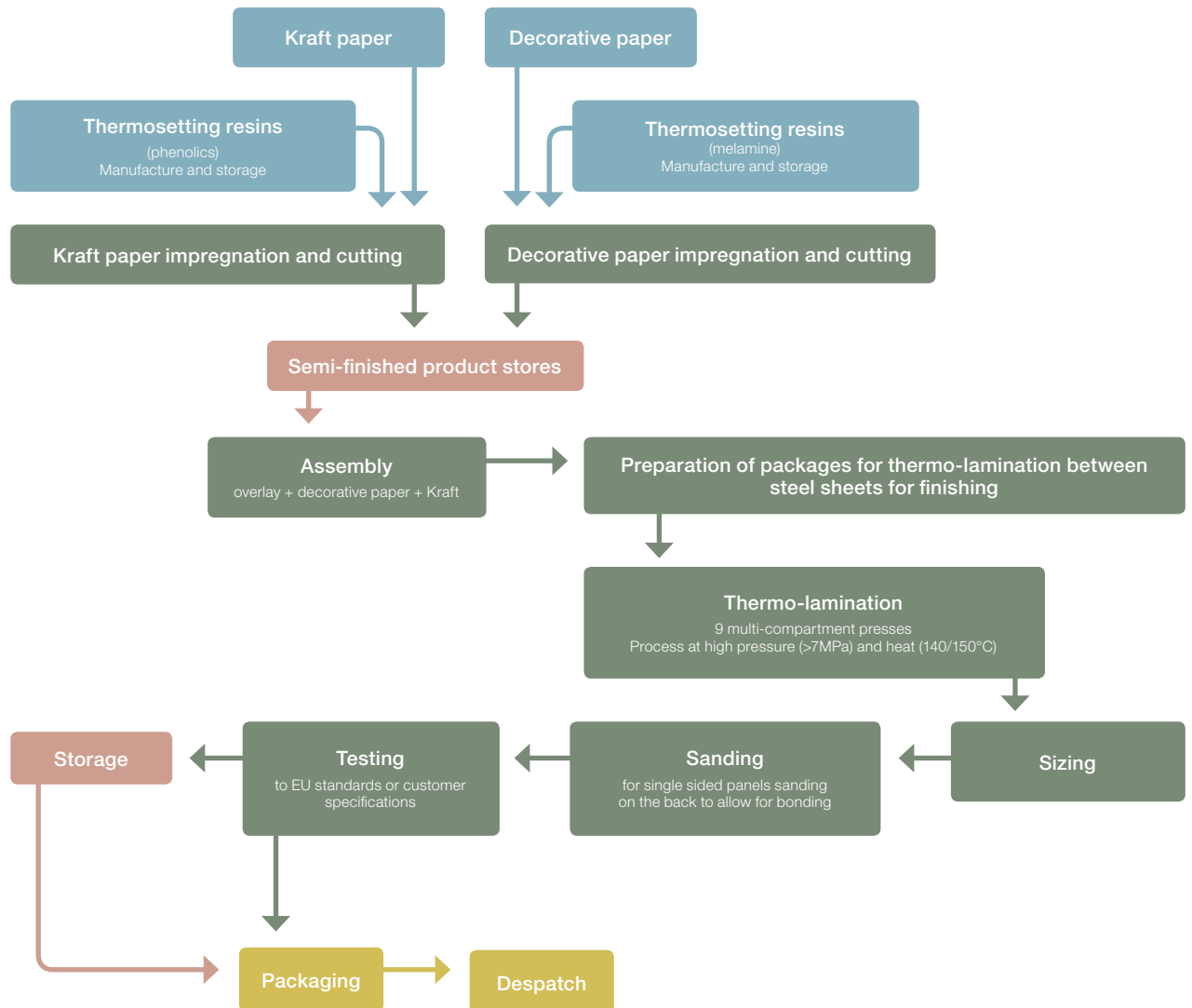

2.2 Panel formats

Arpa panels are available in different sizes and thicknesses. The great variety of sizes (2440x1220, 3050x1300, 4200x1300, 4200x1600, 4300x1850) also allows for different applications, with self-supporting properties in the case of high thickness versions.

The minimum density of the laminate is 1.35g / cm³.

2.3 Finishes

The Arpa catalogue covers a wide range of patterns and finishes that can satisfy multiple design and manufacturing requirements.

In some cases there is a close relationship between the pattern and its finish, while, in others, the finish can be used on most of the patterns.

The finish will never be chosen only for its aesthetic value. The decision must also be based either on the intended use of the finished product or on the type of preparatory work proposed.

Gloss finishes, for example, are less scratch resistant and are therefore less suitable for use on worktops.

Finishes with less highly textured surfaces are easy to clean and are therefore more suitable for use wherever a high degree of hygiene is required.

More highly textured or high-relief surfaces offer greater resistance to wear and chafing.

Light coloured surfaces make scratches or wear and tear less noticeable, while dark ones are less subject to the aging effects of light.

2.4 Table of sizes, thicknesses and finishes

The sizes listed in the chart are those Arpa offers as standard, reflecting the sheet sizes used in Arpa's multi-compartment presses during the high-pressure process.

Laminates can be supplied cut to size or shaped, on request, in the dimensions required for the project.

Dimensions mm	Thickness in mm	Finishes		Typologies
2440x1220	Min 0,6 / Max 30	Erre Lucida Opaca	Quarzo Top Face	Arpa HPL standard Integrale Flooring grade
3050x1300	Min 0,6 / Max 30	Alevé Cliff Corallo Erre Farah Ghibli Larix Lucida Luna Martellata	Mesh Mika Naked Opaca Pesca Pixel Quarzo Satinata Tex Top Face	Arpa HPL standard Arpa HPL PF postforming Integrale Solid Core Unicolor Multicolor Flooring grade Magnetico Naturalia
4200x1300	Min 0,6 / Max 22	Alevé Cliff Erre Flatting Larix Lucida Luna	Martellata Mika OSL Pesca Quarzo Top Face	Arpa HPL standard Arpa HPL PF postforming Integrale Solid Core Unicolor
4200x1600	Min 0,6 / Max 18	Alevé Cliff Erre Flatting Larix Lucida Luna	Martellata Mika OSL Pesca Quarzo Top Face	Arpa HPL standard Arpa HPL PF postforming Integrale Solid Core Unicolor
4300x1850	Min 4 / Max 14	OSL Erre		Integrale

Due to the wide range of patterns, finishes and sizes, please check our website or contact Arpa Customer Service for detailed information on the possible combination.

2.5 EN 438 grades

The minimum requirements, test methods and description of HPL grades are specified in European standard EN 438. This standard sets out an alphabetic classification system using three letters, as follows.

First Letter	Second letter	Third letter	EN 438 (part)
H/V	G/D	S/P/F	Thin EN 438-3
C	G	S/F	Compact EN 438-4
E	G/D	S/F	Exterior EN 438-6
A/M/W	C/T	S/P/F	Design HPL EN 438-8
B/R	C/T	S/F	Alternative Core EN 438-9

Key:

H Also suitable for horizontal applications
 V Suitable for vertical applications
 C Thick (Compact) $\geq 2\text{mm}$
 E Exterior use
 A Pearlescent
 M Metals
 W Wood veneer laminate
 B Multicolour

R Metal Reinforced laminate
 G General purpose
 D Heavy Duty
 C Thick (Compact) $\geq 2\text{mm}$
 T Thin $< 2\text{mm}$
 S Standard
 P Postforming
 F Flame Retardant

2.6 Most common grades

Here are some examples, in accordance with this standard, of common grades of HPL for interior use and their principal applications.

Grade	Properties	Principal Applications
Single sided laminates up to 2mm thick		
HGS	Standard Suitable for horizontal as well as vertical applications that require high performance.	furniture, worktops, kitchens, catering, retail etc.
HGP	Postformable with properties similar to the category above but can be bent and formed at high temperature.	the same areas as HGS, where the project requires curved surfaces.
HGF	High-performance laminate, with specific fire resistance.	Premises that require compliance with fire regulations: schools, hospitals, laboratories, public transport, ships, airports, waiting rooms, railway carriages etc.
VGS	Standard Suitable for vertical as well as horizontal applications that require high performance.	Furniture veneers, cabinets, lifts, doors, offices, wall panelling, kitchens, bathrooms etc.
VGP	Postformable with properties similar to the category above but can be bent and formed at high temperature.	The same as above, where the project requires curved surfaces.
Single sided laminates up to 4mm – double sided from 2 to 30mm thick		
CGS	Thick, compact and integral material for both vertical and horizontal applications.	Furniture, benches, bookcases, transport and sports facilities, where strength and / or self-supporting properties are required
CGF	Thick, compact and integral, with specific fire resistance requirements	The same as above, where there are fire regulations

2.7 Arpa typologies

The wide range of typologies, thicknesses and colours of Arpa HPL laminates offers interior designers, Architects and furniture manufacturers great creative freedom, so they can follow their inspirations without constraint. The specific qualities of each typology make HPL suitable for numerous applications.

Typology	Description
Arpa HPL Std	Standard. Single sided, from 0.7 to 1.8mm thick
Arpa HPL PF	Postforming. Single sided, hot formable into both concave and convex curves. From 0.6 to 1.2mm thick
Integrale	Compact, self-supporting laminate, very stable and hard-wearing. Single or double sided. From 2 to 30mm thick
Solid Core	Self-supporting and compact. Decorative finish with a monochrome "core" available in five colours. From 1 to 12mm thick
Unicolor	Laminate homogeneously coloured throughout its thickness. From 1.2 to 12mm thick
Multicolor	Compact, self-supporting, with layers of different colours. Very thick. Can be routed. From 10 to 14mm thick
Naturalia	Thick material made of wood fibre from certified forests. It is a high density and very high performance product, homogeneous, compact, self-supporting, waterproof and with high load bearing properties. Standard thicknesses 6.4, 9.7 and 12.8mm.

Products for specific applications:

Flooring grade	Laminate with very hard-wearing surface. Designed for flooring in houses and public places. From 0.9 to 1.2mm thick.
Silverlam	Antibacterial, biostatic laminate, due to the silver ions used at the impregnation stage. Suitable for applications wherever hygiene is essential.

3 — HPL PROPERTIES

3.1 Properties of Arpa laminates

The heat (140/150°C) and high pressure (>7MPa) to which it is subjected, ensure that Arpa HPL possesses exceptional qualities of hardness and scratch, impact, abrasion, chemical and heat resistance, properties that make it the ideal material for the widest variety of applications.

Its main mechanical, physical and chemical characteristics are as follows.

- Attractive aesthetic qualities
- High mechanical strength
- Flexibility
- Dimensional stability
- Durability (impact, wear and graffiti resistance)
- Lightfastness of colour
- Good chemical resistance
- Resistance to the effects of water, steam, heat and frost
- Good fire resistance
- Ease of cleaning
- Hygienic qualities
- Anti-static properties (does not attract dust)
- Ease of installation

For more information download the **Product data sheet HPL (pdf)**

3.2 Hygiene

HPL laminate surfaces are durable, compact and highly impermeable due to the melamine resin they are made from and are not damaged by food and chemicals commonly used in the home; HPL is a thermosetting material and does not react with these substances.

It is not subject to corrosion or oxidation and therefore does not require additional protective enamel or varnish.

It is hygienic. It represents hostile territory for the proliferation of germs and bacteria and, unlike other materials of synthetic origin, has antistatic properties and therefore does not attract dust.

In addition, HPL laminate panels may be of large dimension and are therefore ideal for cladding extensive areas without joints or crevices where dirt could more easily collect. They are therefore particularly suitable in all situations that require maximum hygiene, from kitchens to operating theatres.

3.3 Suitable for contact with food

Arpa HPL is ideal for convenience, hygiene, durability and ease of cleaning. It also represents a hostile territory for the proliferation of germs and spores and is therefore an ideal material for all applications involving direct contact with food.

3.4 Resistance to bacteria

HPL are more hygienic and easier to clean than ordinary furniture finishes. One of the properties of Arpa HPL is exceptional resistance to the growth of micro-organisms such as bacteria, moulds and fungi. This quality makes them ideal for applications where hygiene plays an essential role. Arpa has a special laminate in its collection with even greater hygienic properties. Silverlam is a biostatic, microbiologically tested laminate, which inhibits bacterial growth and reduces the number of bacteria by 99% in 24 hours. The active ingredient ensuring this level of performance is silver ions.

3.5 Reaction to fire

In general, HPL laminates have excellent fire performance with low smoke emissions. In the event of fire, they do not catch fire easily (only at very high temperatures) and do not soften or run. Arpa Flame retardant HPL categories, in particular, have specific properties that retard the spread of flames.

Arpa's Flame Retardant HPL can achieve Euroclass B, i.e. the best performance possible for an organic material. The standard grade, however, meets the requirements of Euroclass D.

3.6 Formaldehyde release

The very low permeability of HPL provides a barrier against the possible emission of formaldehyde and other volatile substances (VOCs) that might come from any timber substrates forming part of composite panels.

Arpa laminates have obtained "GREENGUARD Indoor Air Quality" and "GREENGUARD Children and Schools" certification and sustainability certificates which set even more restrictive criteria.

3.7 Performance evaluation

For each different typology of laminate there are specific features, in relation to the intended purpose, which are evaluated using the test methods described in EN 438 and ISO 4586. So, as required by these rules, each ARPA product is subjected to rigorous tests and measurements.

For information on the specific properties of every typology of Arpa laminate, up-to-date product data sheets can be consulted on the arpaindustriale.com website.

3.7 How to read en 438

As mentioned, EN 438 describes the test methods to be used and these vary depending on the area of application for that particular typology of HPL. The table below shows which are the relevant parts of the standard.

Application	Part 3	Part 4	Part 5	Part 6	Part 8	Part 9
Construction (interior use)	●	●			●	●
Construction (exterior use)				●		
Transport	●	●			●	●
Furniture	●	●			●	●
Flooring			●			

4 — MAINTENANCE AND CLEANING OF HPL

4.1 Maintenance

HPL surface should be cleaned regularly but does not require any special maintenance, just a damp cloth with warm water or mild detergents. Almost all normal household cleaning products or disinfectants are tolerated perfectly well, as long as they are not abrasive or highly alkaline.

The table below shows the cleaning products and methods best suited to different types of dirt.

4.2 Recommendations for cleaning the surface of HPL for interior products

Type of dirt	Recommended cleaning product and method of application
Syrup, fruit juice, jam, spirits, milk, tea, coffee, wine, soap and ink	Water with a sponge
Animal and vegetable fats, sauces, dry blood, dry wine and spirits, eggs	Cold water with soap or household detergent with a sponge
Smoke, gelatine, vegetable and vinyl based glues, organic waste, gum arabic	Hot water with soap or household detergent with a sponge
Hair spray, vegetable oil, biro and felt tip pens, wax, foundations and greasy make-up, residual solvent marks	MEK, alcohol, acetone with a cotton cloth
Nail polish, spray lacquer, linseed oil	Acetone with a cotton cloth
Synthetic oil paints	Trilene nitre based solvent with a cotton cloth
Neoprene glues	Trichloroethane with a cotton cloth
Traces of silicone	Wooden or plastic scraper, taking care not to scratch the surface
Lime deposits	Detergents containing low percentages of citric or acetic acid (10% max.)

For more details, refer to the working guide.

4.3 General precautions

For best results in cleaning HPL, it is important to remember certain precautions:

- Although very durable, the surface of HPL must still never be treated with products containing abrasive substances, abrasive sponges or unsuitable products, such as sandpaper or steel wool.
- Products with a high acid or very alkaline content should be avoided because they can stain the surface.
- When using solvents, the cloth used must be perfectly clean so as not to leave marks on the HPL surface. Any streaks can still be removed by rinsing with hot water and drying.
- Avoid furniture polishes and wax based cleaners in general, because they tend to form a sticky layer on the dense HPL surface, to which the dirt adheres.

5 — WORKING WITH HPL

5.1 How to transport hpl

HPL laminates must be handled with great care to avoid breakage and damage. When loading and unloading, they should therefore be lifted and not slid, preferably back to back, in pairs, because one panel rubbing against another can cause surface scratches and abrasions.

Individual sheets should be carried with the decorative finish towards the carrier's body; if they are large, two people are needed and it is easier to handle them by bending them in a lengthwise direction.

In the case of thin laminates (up to 1.2mm), the sheet can be carried by rolling it up, with the decorative side facing inwards to form a cylinder about 600mm in diameter or at least large enough not to damage the laminate.

To carry stacks of laminate sheets, platforms of adequate size and solidity should be used and the sheets secured with straps or stretch film to avoid them slipping dangerously.

During transportation, the decorative side of the sheet should be turned toward the body of the carrier.

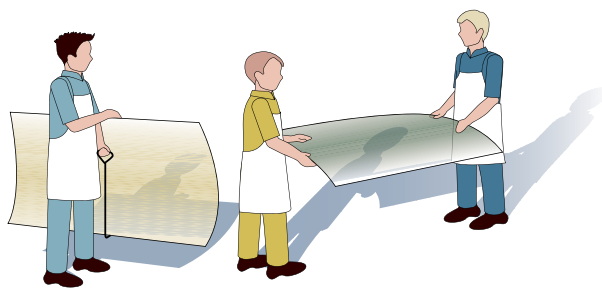

Handling of large sheets always requires two people

5.2 How to store hpl

The sheets of HPL laminate are placed in pairs and with the decorative sides one against the other, on flat, horizontal shelves; the outer sheet will have the decorative side facing downwards to prevent the surface being damaged or distorted and it is a good idea to protect it with a polythene sheet or a larger sized hardboard panel.

If horizontal storage is not possible, the sheets can be placed in piles at an angle of 60 - 70°, with the whole surface area resting against a rigid support and making use of any device that will help prevent them slipping.

Decorative laminates should always be kept in an enclosed space at a temperature of between 10 and 36°C and humidity between 60 and 65%.

It is also important to remember that the longer the HPL laminates are kept in stock, the greater the risk of warping, so if they have to be stored for an extended period, it is always better to secure them with straps.

Correct horizontal storage.

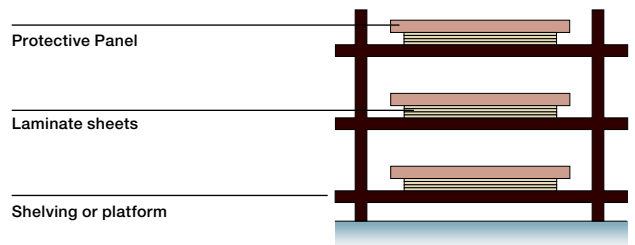

Note to laminates with adhesive protective film

The protective films are designed for temporary surface protection against dirt, scratches and tool marks; they are not designed for protection against corrosion, humidity or chemicals.

The laminates covered with the protective film shall be stored in a clean, dry place at room temperature (optimum 20°C), avoiding weathering and UV exposure.

The protective film must be removed from the surface of the laminates after the application and before putting into use the finite element. In case of thick laminate with the protective film on both sides, it must always be removed from both sides at the same time. In any case, the removal must be made within six months from the date of shipment by Arpa Industriale.

Pay close attention to heating in case of postforming. The Customer has to test the postforming process conditions and carry a trial prior to go in a full scale production.

Arpa Industriale cannot be responsible for the misuse of the laminates covered with the protective film, nor for the consequences for non-recommended applications.

The sheets that do not support the entire surface to a rigid support tend to slip and to bend.

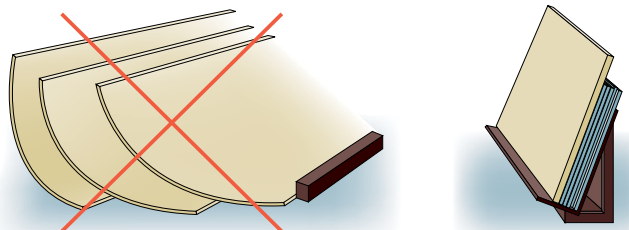

5.3 How to cut HPL

The decorative side of the HPL laminate sheet is impregnated with melamine resin, which makes the surface hard and uniform.

It should preferably be cut with saws using blades with tungsten carbide inserts; these are long-lasting, but must be handled with care since they can easily be damaged if they come into contact with metal surfaces. They are especially recommended for cutting standard and compact laminates.

Please note: for the Flooring grade, blades with diamond inserts are recommended because they stay sharp for longer and are therefore longer lasting.

5.3.1 Cutting by hand

Portable circular saws are used only in certain circumstances, where on-site work is essential.

The saw must be well sharpened so that great pressure is not required and this reduces the risk of the laminate chipping and / or cracking. The operation should always be carried out in compliance with codes of practice and safety regulations.

Profiles of the tungsten or diamond inserts fitted to the saw discs currently available.

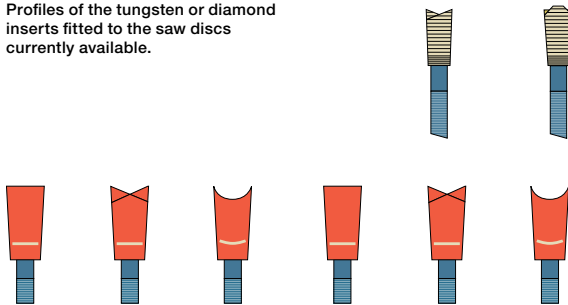

5.3.2 Cutting with bench machinery

This essentially entails circular saws.

To get good results with bench circular saws it is essential:

- to place the laminate with the decorative face in the opposite direction to the rotation of the blade. In addition, the sheet must be well supported and held in place with an adjustable height pressure tool to prevent movement and vibration.
- to use an accurate guide,
- to make sure that the saw blade is aligned with the worktop and projecting the right amount.

It is also possible to cut several sheets of laminate together. In the case of single sided sheets, all the sheets should be located with decorative sides facing upwards.

In the case of double sided sheets, to avoid any chipping caused as the disc exits the lower face, machines fitted with a scribe should be used before the actual cutting.

Alternatively, the stack of sheets should be placed on a "sacrificial panel" that is at least as hard and substantial as the laminates that are being cut to shape.

Recommended specification for circular saws:

- Tooth pitch, 10 to 15mm.
- Cutting speed, 3,000 to 4,000 rpm
- Tip speed, 60 to 100m/ s
- Forward speed, 15 to 30m / min.

The blades should not be too thin; if they are less than 2mm thick, they lose rigidity and then vibrate, making the cut less precise.

Blade advancement scheme.

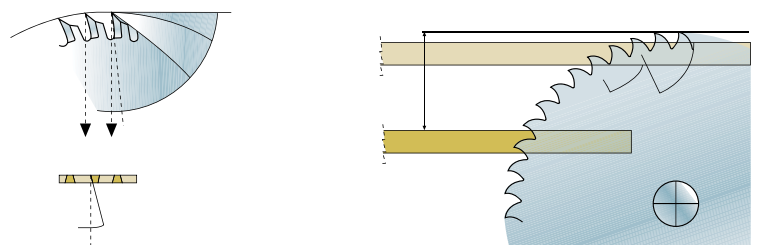

5.3.3 Cutting composite panels

Everything mentioned so far also applies to the cutting of composite panels with decorative laminate glued onto one or both sides of the substrate.

In this case too, band saws are not recommended.

Best results are achieved with fixed circular saws fitted with scribes and by carefully adjusting the blade height.

The quality of the cut also depends on the profile and the number of teeth, the tip speed, the forward speed and the blade's angle of entry and exit.

For cutting laminate and composite panels it is a good idea:

1. to choose the most suitable blade
2. to use a low forward speed and not "attack" the material;
3. to vacuum the dust during the work.

Operations should be carried out in compliance with codes of practice and safety regulations.

Circular saws

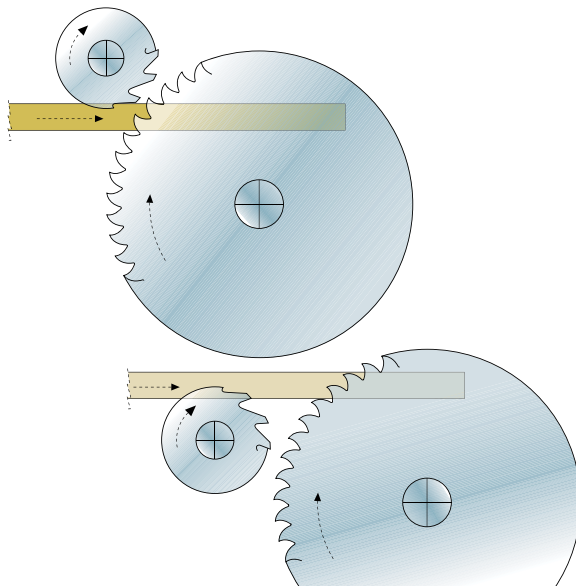

5.4 How to mill HPL laminate

Depending on the circumstances, milling can be carried out in various ways, using portable tools or fixed equipment.

5.4.1 Milling with portable cutters

For an accurate job it is always essential to use machining centres.

Portable cutters, as well as belt sanders or grinding wheels, are used especially to trim the projecting edges of panels already glued onto a substrate.

In this case, the base of the cutter must be covered with felt to protect the decorative finish side during the work. The laminate surface should be cleaned of any dust and grit and it is essential to remove the chips during the operation, by vacuuming.

For the machined part to be properly finished, a rotation speed of at least 20,000 rpm is required.

Cutters with two blades, one straight and one angled, are suitable both for a square cut and for chamfering.

To avoid damaging the tools, the section of laminate to be milled should not project beyond the backing by more than 2 to 3mm. For continuous operations or for major projects, the use of power tools with parallel blades is recommended.

5.4.2 Milling with fixed equipment

Milling machines or wood machining centres with chucks with interchangeable blades can be used. The recommended tool attachments are cutters, discs or drill bits in solid tungsten carbide or in steel with tungsten carbide or diamond inserts, with one or more vertical or angled teeth. In the case of curved edges, it is better to cut out the rough shape required first, leaving a 1mm surplus. The next step is milling to the finished shape required.

5.4.3 Smoothing by hand

To finish the edges or chamfer the corners by hand, various tools such as files or sandpaper can be used.

To trim the edges or chamfer the sharp corners, square (rather than milled) files are used, making sure to use them in a direction away from the decorative side towards the core.

It is also possible to use fine files or abrasive paper (100-150 grit sandpaper) and dual speed scrapers. To avoid scratching, it is important to proceed gently and possibly in two stages, first with a coarser and then with a finer sandpaper.

5.5 How to drill HPL

The techniques shown are valid both for drilling individual sheets of HPL laminate and for drilling those already glued to a substrate.

Naturally these operations should also be carried out in compliance with codes of practice and safety regulations.

For best results and to avoid the risk of future splits or cracks, it is important to remember the following:

- Holes for screws should have a diameter at least 0.5mm greater than the diameter of the screw itself. This is because the screw must have some “play” in all directions without touching the edges of the hole, to allow for slight dimensional movements in the laminate caused by changes in environmental conditions and to avoid cracks appearing around the actual hole.
- The drill speed should never be such as to overheat the melamine surface of the decorative laminate and damage it.
- To avoid splintering the material around the drill bit's exit hole, it is a good idea to place the laminate on a hard wooden board.
- To prevent round head screws as well from “gripping” too tightly, plastic or rubber washers can be fitted.
- After drilling, it is advisable to check that the edge of the hole is clean and smooth. Should it not be, carefully rectify it because any micro-spalling can lead to cracking in the future.

5.5.1 Drilling tools

The choice of tools depends on the size of the hole that has to be made. Basically it involves pillar tools, hand tools or a machining centre that can mill as well as drill.

a) Twist drills

The most suitable bits for drilling decorative laminates are special steel twist drills for plastics, with a point angle of 60° to 80° (rather than the 120° of normal metal bits), a sharp helix angle and a wide flute for rapid chip removal. The recommended rake angle is 7° with an 8° angle of attack.

b) Hole cutters

These are recommended for larger holes.

Drilling with helical wick

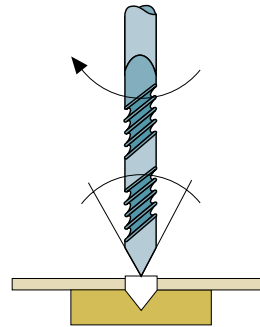

Drilling with milling cutter

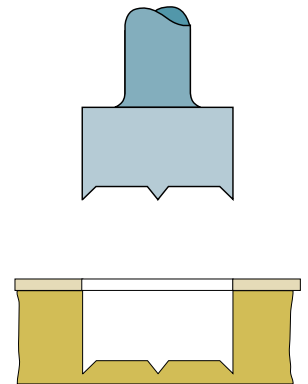

5.6 How to make internal cuts

The following refers both to laminate sheets and to composite panels with HPL laminate applied to one or both sides.

When carrying out internal fretwork, it is important to know that right angled cuts can cause breakage or cracking of the laminate. In order to avoid these, all the corners of the internal cut-outs should be evenly rounded, polished and brushed to remove any chips. The inner radius of the rounded corner must be as large as possible.

For internal cut-outs with side dimensions of up to 250mm, the rounding of the corners should create a radius of at least 5mm. If the length of the cut is greater, the radius of the corners should be greater too.

Before cutting the side of the opening, it is better to form the interior angles directly with the milling machine or drill, rounded to the required radius.

If the design requires interior right angles, this should be achieved by placing HPL laminate panels together at each corner with butt joints.

Cutouts-angle can cause cracking or fissuring of the laminate.

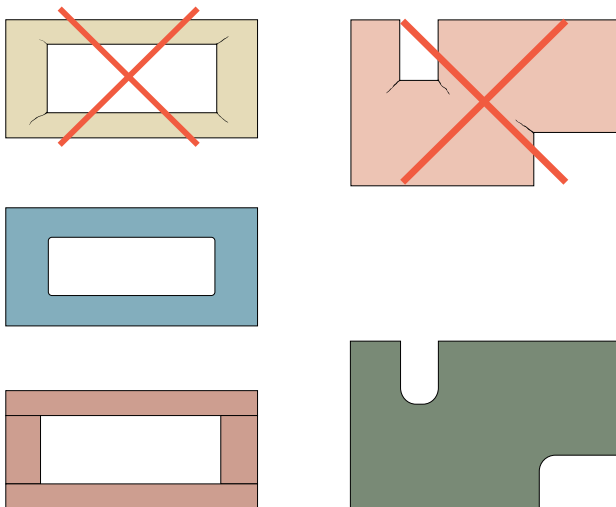

Interior trim corners should be rounded.

6 —POSTFORMING

6.1 How to hot-form postforming laminates

The postforming type of laminate was created in response to both aesthetic and functional requirements. Curved surfaces may actually be more attractive than those with sharp corners and are more hygienic because they have no joints where water or dirt can accumulate.

Post-forming laminates retain the properties of standard HPL but they can be bent to concave or convex curves. This process is called postforming and can only be applied to the type of laminate specifically called HPL Postforming. The postforming technique allows a panel of a certain thickness to be profiled in cross-section. Depending on the application, the resulting panel may be:

- most commonly, a composite product made of thin laminate glued onto a substrate, usually wood-based.
- In postforming the laminate to be bent is heated to temperatures that vary depending on the thickness and degree of curvature required.
- The best results are achieved by heating the area to be bent quite quickly to the right temperature.
- For any given thickness, laminates made to have greater fire resistant properties are less easy to postform.

6.2 Postforming temperature

The temperature to which laminates are heated for postforming ranges from the lowest temperature at which they can be postformed without breaking or cracking to the highest temperature at which they can be postformed without forming blisters and delaminating.

For their own laminates, Arpa recommends an appropriate combination of temperature (150°C to 160°C, normally not exceeding 163°C), forward speed and heating time (normally not more than 10 seconds) relative to the required radius of curvature. This is a general indication, as conditions depend on the technique chosen.

Laminates with a white decorative finish should always be postformed at the highest temperature in this range.

It is always essential to monitor the temperature carefully throughout the entire process. The heating may, in fact, not proceed uniformly, due to changes in ambient temperature, variations in the heater voltage or in the speed of the equipment. With insufficient heating, the laminate can break completely or partially crack while, with excessive heating, the layers that make up the laminate can separate and blisters can appear. To check the temperatures, simple solid indicators can be used to register the surface and, by melting at a set temperature, these indicate the precise moment when the laminate reaches the required temperature. Alternatively infrared detectors can be used.

Please note: if HPL laminate is stored for several months under imperfect temperature and humidity conditions, it is highly advisable to perform a test on a sample before starting the whole postforming process.

6.3 Machinery

The postforming operation can be carried out with either static or continuous machines. With the former, the laminate remains stationary during the heating process and the bending operation makes the curved profile adhere to the substrate. With the latter, the laminate is taken on a conveyor or belt, first into the heating and then into the forming zone. With static machines, bonding can be done with almost any type of adhesive.

Among continuous machines, however, there are some that require the use of PVAc adhesives, while others use contact adhesives.

Heating can be carried out with infrared equipment, heated plates or bars or heated metal tubing. There are several factors that affect heating performance, including the heat source, its distance from the workpiece to be heated, the type of laminate and its thickness, the adhesive, the ambient temperature, the temperature of the laminate and the backing and the forming speed. It is therefore essential that each machine should be calibrated beforehand.

The bending speed depends primarily on the thickness of the laminate, the radius of curvature, the type of curvature required, concave or convex, and whether the laminate is bent in a direction that is parallel to or across the cellulose fibres. The direction of the fibres is the same as the sanding direction of the reverse: lengthwise (L) is parallel and widthwise (T) is perpendicular to the direction of sanding. The normal postforming direction is lengthwise. Bear in mind that it is also possible to bend in a widthwise direction but, as this is relatively more difficult, with a greater risk of cracking than in a lengthwise direction, it is necessary to proceed under different conditions and to check them in advance.

6.4 Postforming technique

The technique of postforming generally entails shaping the substrate as a first step, according to the profile required. This can then be followed by two procedures:

1. the sheet of laminate is postformed and then bonded to the substrate, ensuring that it adheres fully to the backing over both the flat section and the rounded profile, using a certain amount of pressure (2 separate operations);

Postforming and bonding in two phases.

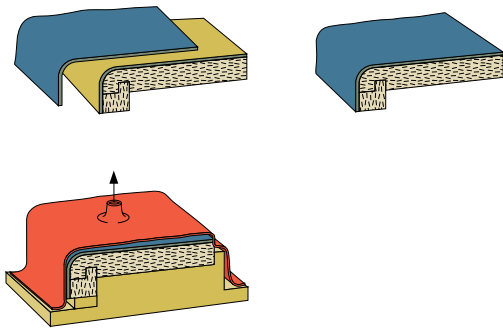

2. the laminate is bonded to the substrate in the area that will remain flat and is then postformed along the profile of the backing, while at the same time making it adhere to the rounded edge using a certain amount of pressure (a continuous process is recommended for mass production).

Continuous postforming and glueing process.

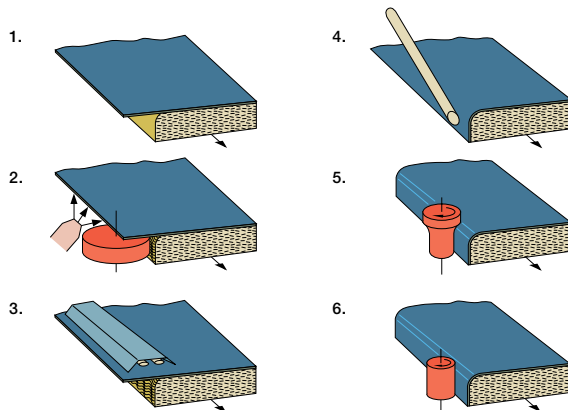

The substrate requirements for PF laminates are the same as for standard laminates. For the laminate to adhere perfectly to the curved profile, it is a good idea to choose substrates with edges that can be easily shaped and neatly and cleanly trimmed.

Chipboard

It is essential that the chipboard is of good quality with a smooth and uniform surface that the chips do not come loose from while the edges are being shaped. It is then advisable to use a brush to remove the chips created when shaping the profile.

MDF

This is ideal for producing smooth-edged profiles

Plywood

Shaping the edge of plywood is difficult. The blades must be very sharp and very clean. After shaping the edges, a sanding operation is recommended followed by brushing.

Solid Wood

Solid wood may shrink and cause undulations to appear on the surface of the laminate, so it is preferable to use MDF or chipboard substrates.

7 —PRECONDITIONING

7.1 How to prepare hpl laminates and substrates

High-pressure decorative laminates are made of up to 60 / 70% cellulose fibres. These are very sensitive to changes in temperature and, especially, humidity and react with dimensional movements. The dimensional changes in HPL may be different from those of the backing and therefore cause distortions in the finished panel.

This can be avoided by:

- Preconditioning both the backing and the laminates prior to bonding
- Balancing the composite panel so that the two outer faces consist of laminates with identical properties
- Ventilation and humidity control in the room where the composite panel is installed
- Installation of the panel in such a way as to allow any dimensional changes

7.2 Pre-conditioning

In order for the decorative laminates and the substrate to achieve a balanced and stable humidity level, they must both be pre-conditioned at the same time before they are bonded together. This operation enables any differences between the materials to be minimized, especially in the event of changes in environmental conditions, which are the causes of stresses. There are “hot” and “cold” techniques to help achieve this.

7.2.1 Cold pre-conditioning

Method A.

The decorative laminates and substrates are stacked and shut away together for at least three days in a room with humidity and temperature levels similar to those where the finished panels are to be installed. If these are to be installed somewhere hot and with consistently low humidity, the components must be conditioned in a hot and dry atmosphere to avoid subsequent shrinkage.

Method B.

Laminates, substrates and adhesives are placed in a room for ten days at a temperature of between 18 and 20°C, a humidity of 50% and with good air circulation.

Method B

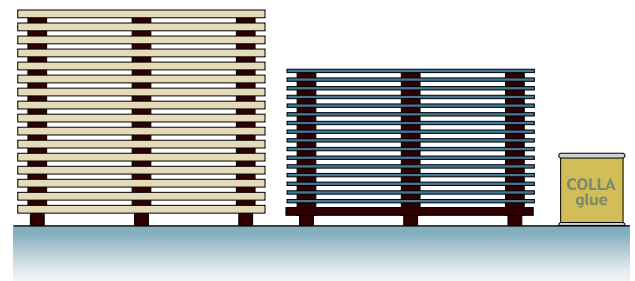

Method C.

The sheets of laminate that will form the opposite faces of the same panel are stacked in pairs in a dry room for at least three days, with the back sanded faces in contact, until they achieve an almost identical moisture content. After bonding, every movement caused by changes in humidity will be similar in magnitude and direction on each side of the panel, reducing the risk of distortion. With this method, there is no need to condition the substrate in the same place.

Method C

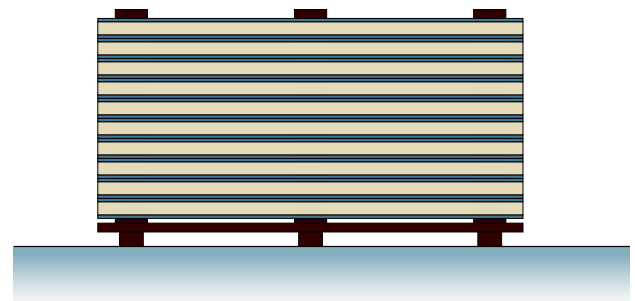

7.2.2 Hot pre-conditioning

The sheets of laminate are arranged in pairs, spaced apart, so as to allow hot air to circulate. Duration and temperature will vary depending on the type of glue used (for example, 10 hours at 40°C or 6 at 50°C).

If it is necessary to speed up the operation, the laminates can undergo an accelerated partial drying process, placing them, separated by battens, in a small heated room, for about 3 hours at a temperature of 40°C or for 2 hours at a temperature of 50°C.

A heat press can also be used to speed up the operation even further, with panels put in two at a time (face to face) for about ten minutes. The bonding should be carried out several hours later.

For pre-conditioning, the panels should be placed, backs together in pairs with spaced slats to allow air circulation.

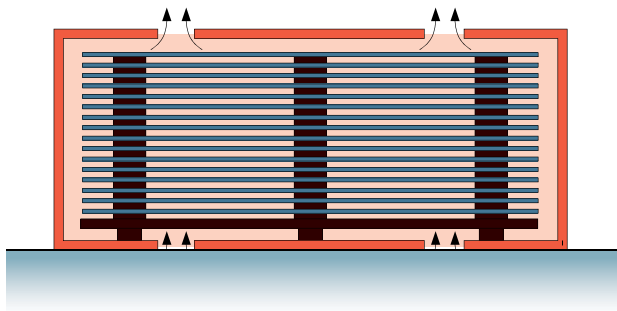

Please note: These guidelines apply when environmental conditions at the panel's intended location are temperate. For extreme conditions, it is advisable to refer to Arpa Industriale customer services.

If the composite panel's final destination is one with low relative humidity, it is advisable to pre-condition both the substrate and the laminate at a similar relative humidity and at room temperature or at a higher temperature for a shorter period; e.g. 20 hours at 40°C or 10 hours at 50°C. It is never advisable to exceed 50°C. Bonding should be carried out immediately after pre-conditioning, strictly in accordance with the manufacturers' recommendations.

7.3 Balancing the sheets

Stresses may occur between two different materials bonded together.

To avoid subsequent distortion in the resulting panel, it is therefore desirable to use materials with identical properties on both sides, subject to the same dimensional changes in relation to environmental variations. This is an essential strategy, especially if the panel is self-supporting or not directly supported by a rigid structure.

The larger the area to be clad, the more essential it is to consider these factors: choice of the most appropriate sheets for balancing the panel, density, symmetry and the rigidity of the substrate.

Ideally the laminates to be used for both sides of the finished composite panel should be taken from the same sheet of laminate or from laminates of the same type, thickness, pattern, finish and production batch and from the same manufacturer.

It is important that the two laminate faces are cut in the same direction, i.e. in the fibre direction of the paper, which is the same as the direction of sanding. In this way, the dimensional movement of the laminate will, in fact, be minimal compared with what would occur if the faces were cut in the opposite direction.

Although not recommended because the risk of warping cannot be totally ruled out, it is possible, in standard and non-critical applications, to use materials other than laminate on one side of a composite panel (metal sheets, wood veneer, coats of lacquer, impregnated papers etc.). Naturally, it is important to choose materials with physical properties more like those of the laminate, as the more these differ from those of the laminate, the more likely it is that stresses will be created due to the lack of symmetry.

7.4 Ventilation and humidity control

HPL sheets (both thin and thicker varieties) can be covered on both sides with a protective film. To store them properly, the protective film should never be removed from just one side.

It is also important to remember that High-Pressure Laminates and wood fibre substrates are materials that are sensitive to humidity changes in the air. HPL, for example, expands by about 1.5mm per linear metre in both lengthwise and widthwise directions.

So adequate space for expansion should be provided between one sheet and the next.

8 — MANUFACTURE OF COMPOSITE PANELS

Decorative laminate is a semi-finished product that, in almost all applications, is bonded to a substrate.

8.1 Substrates

The substrate supports the laminate and must resist distortion. The material it is made of should therefore be selected according to the characteristics of the application, the intended use of the composite panel and the environment in which it is to be installed:

- stability,
- flatness,
- rigidity,
- mechanical properties,
- uniformity of thickness,
- water and humidity resistance,
- fire performance properties.

For the surface of the laminate to appear perfectly smooth and uniform, the surface of the substrate must be too. Imperfections in the substrate, in fact, tend to be transferred to the laminate surface, especially if the sheet is very thin. With a smooth, shiny finish, the imperfection is very obvious. Chipboard and MDF panels are generally excellent substrates because they experience similar dimensional movements to those of decorative laminates, as they are themselves made of cellulose. In other cases, metal or mineral-based, kraft paper and foam plastic substrates are used instead.

8.2 Adaptability of substrates

In the table below is a list of substrate materials that can be combined with decorative HPL laminates and their degree of adaptability.

Substrate	Degree of adaptability
Panel of particle board (Chipboard)	<p>Fixing methods depend on the thickness of the composite panel.</p> <p>The structure of chipboard (chip shape, resin content, density etc.) greatly influences its surface quality and characteristics.</p> <p>The most appropriate chipboards for bonding to decorative laminates are multilayer chipboards.</p> <p>P3 EN 312-3 type chipboards are an ideal backing for decorative laminates in areas with a dry atmosphere and they can also be manufactured with fire-resisting properties.</p> <p>P5 EN 312-5 type panels are more resistant to moisture and can be installed in areas of greater humidity.</p> <p>To avoid damage due to shrinkage and distortion, the panels should be sanded evenly on both sides.</p> <p>Panels must meet the minimum requirements of the standards. The nominal density should be no less than 650kg/m³</p>
Medium or high density fibreboard (MDF - HD)	<p>These should be sanded before bonding (usually carried out by the manufacturer).</p> <p>They are made using a dry process and use synthetic resins for bonding the wood fibres together; they have a uniform structure and a fine texture that enables well-shaped finishes to be achieved, with smooth edges.</p> <p>They can be treated to increase fire and moisture resistance.</p> <p>Their nominal density should be no less than 800kg/m³.</p>
Plywood panels	<p>Thin panels are not self-supporting. Fixing techniques depend on the thickness of the composite panel. Low-density plywoods in hardwoods such as poplar are particularly suitable for bonding to decorative laminate.</p>
Laminboard panels	<p>Laminboard panels are suitable only if formed of narrow enough strips. Otherwise, surface undulations may appear in low humidity conditions.</p>
Honeycomb structure substrates	<p>These can be used as internal components of a substrate or combined with a frame.</p> <p>They can be made of wood, metal, impregnated paper, cardboard (recycled or otherwise), polycarbonate or polypropylene.</p> <p>In aluminium, they are ideal for creating panels that are rigid but light, finished with decorative laminates on both sides. They come in different thicknesses and various cell sizes and are bonded with epoxy resin-based adhesives. In non-impregnated Kraft paper – they are generally used as a core in plywood sandwich panels or panel doors; they are also used with direct lamination in applications where weight restrictions or impact resistance are more important.</p> <p>Impregnated Kraft paper - resists moisture better when impregnated and is normally used in small cell formats. Plastics such as polycarbonate and polypropylene are durable, light and not sensitive to moisture.</p>
Mineral-based substrates	<p>Concrete, calcium silicate or vermiculite panels.</p> <p>There are several non-combustible substrates, mostly calcium silicate-based. Decorative laminates should be used only on substrates formed from a single block because these are more resistant to delamination.</p>
Metal substrates	<p>The dimensional movement of metals is different from that of decorative laminates.</p> <p>Aluminium and steel are suitable substrates if their surface is prepared carefully before bonding the laminate to it (with PUR or epoxy glue).</p>
Foam plastics (polystyrene, PVC, polyurethane, phenol based etc.)	<p>Rigid foams are self-supporting substrates, with good thermal insulation and are suitable for direct lamination.</p> <p>Phenolic foams have good fire resisting properties.</p> <p>They can also be found as the "core" in timber frames.</p>

8.3 Substrates not recommended

Plaster or concrete surfaces	The uneven surfaces of these substrates do not normally lend themselves to the direct application of laminates. In addition, the dimensional movements of the materials are well-nigh incompatible.
Simple plaster or wallpaper surfaces	The dimensional movement of the decorative laminate on the paper could result in breakage.
Solid wood	This is unsuitable. The irregular dimensional movements cause surface undulations. As a substrate for laminates, it can only be used in small areas.

8.4 How to bond laminates to substrates

Firstly, prior to bonding, the laminate surfaces and substrates should be thoroughly cleaned of any dust, grease or other particles that could cause defects or stains.

8.4.1 Bonding temperature

Normally, bonding is best carried out at room temperature, but never below 15°C. At higher temperatures the “grab” time of the glue is reduced. It is advisable to carry out tests to check how the glues react in the particular environmental conditions.

8.4.2 Adhesives

The choice of glue from among the many types available should be determined by the type of substrate and the purposes the finished product is to fulfil.

8.4.3 Classification of adhesives

Based on their reaction to heat:

Thermoplastic adhesives

These soften with heat. This group includes chloroprene and neoprene-based glues, those based on pvac (polyvinyl acetate), silicones, acrylics, thermo-melting (hot melt) and special glues.

Thermosetting adhesives

These harden when heated, after initially softening. Belonging to this group are glues based on urea and formaldehyde, melamine and formaldehyde, resorcinol and formaldehyde, the phenolics, the polyurethanes (one or two-pack pures) and polyester and epoxy resins.

Based on method of application:

High-pressure adhesives

- A) high pressure and long duration.
Pressure is exerted by a mechanical or hydraulic press on the laminate and substrate, which are in full contact and at a set temperature, e.g. 80 / 90°C for textured finishes and a maximum of 60°C for gloss and semi-gloss finishes.
Belonging to this group are pvac, acrylic, urea resin, phenolic and resorcinol and formaldehyde-based glues.
- B) high pressure and short duration.
Pressure is exerted for a short time (static pressure contact adhesive), but distributed evenly by hammering or using a rubber roller, in other words placing a load on the panel being manufactured.
Belonging to this group are: neoprene - chloroprene - pvac b2-b2.

Light pressure adhesives

- A) light pressure and long duration
Polyester-based glues
Pur polyurethane glues
Epoxy glues
- B) pressure exerted and short duration
Thermo-melting (hot melt) glues

(Applied with special equipment).

8.4.4 Bonding with presses

There are two possible methods of bonding with presses:

- With cold presses. These can be used with steel sheets and limited pressure. The best results are obtained with gloss and semi-gloss finishes.
- With hot presses. These can be used with stainless steel sheets, placing a sheet of laminate in every empty compartment. As an indication, for gloss finishes the maximum temperature is 50°C and the pressure 0.200g; for textured finishes the maximum temperature is 70°C and the pressure 0.500g.

8.5 Hardeners

Neoprene-based adhesives are used with a hardening agent, which increases the glue's heat resistance. Thermosetting adhesives are used with accelerators and catalysts, which ensure a good “grab”, reducing the temperature and the period of application.

8.6 Types of adhesive

Thermoplastic adhesives	Neoprene/Chloroprene	Polychloroprene-based. Available in solvent or aqueous solution, with or without hardener.
	PVAc	Polyvinyl acetate-based emulsion. Available as one or two-pack; the latter shows greater resistance to heat and humidity. If the substrate is compact and uniform, this ensures a good bond, being easy to use and fast setting. Being liquid, it should be distributed carefully over the surface to prevent fibres or chips lifting at a later stage.
	Acrylic compounds	
	Silicones	
	Hot melt (Thermo-melting)	Almost exclusively used for bonding edges and assembling pieces. Not to be used in proximity to hot surfaces.
Thermosetting adhesives	Urea glues (UF)	Urea and formaldehyde-based. Durable and resistant to high temperatures but with poor water resistance. Applied with presses at high temperatures.
	Melamine glues	Synthetic resins obtained by polycondensation of formaldehyde with melamine. Water, abrasion and heat resistant with considerable transparency to light radiation.
	Resorcinol and formaldehyde-based glues	Use with hot or cold pressure for bonding the laminate to moisture-resistant and some fire-resistant substrates. Good weathering resistance.
	Phenolic glues	Resistant to water, weathering and high temperatures. They reduce considerably in volume while setting.
	Polyurethane glues	These are strong and flexible and adhere well to smooth or porous surfaces; they withstand low temperatures better than other glues, while not tolerating high temperatures well. They have good cavity-filling properties. One or two-pack, they are excellent for bonding laminates to difficult substrates such as polystyrene, metal, mixed materials etc.
	Polyester	This is more sensitive to heat than other adhesives.
	Epoxy resins	These bond well to many materials and require only light pressure. The wide range of hardeners available for epoxy glues allows setting times to be achieved ranging from a few seconds (if the temperature is high) to many minutes or hours (at room temperature). They are strong and durable, have good cavity-filling properties and reduce very little in volume after drying.

8.7 Glues and substrates

- can be used with that substrate

Substrates	Thermosetting adhesives					
	Neoprene Chloroprene	PVAc	Silicones	Acrylic compounds	Hot melt (Thermo-melting)	Special glues
Wood-based	● Cold Treatment	● Hot Treatment			●	
Paper based honeycomb structure	● Cold Treatment	● Hot Treatment				
Plastic foam or honeycomb material-based: polystyrene				●		
Pvc ²	●			●		
Phenol-formaldehyde	●	●				
Polyurethanes	●					
Metal-based, in sheets or honeycomb structures	●				●	
Mineral substrates in sheets or plaster-based foams		●				
Concrete	●	●				
Aerated concrete	●	●				
Glass foam	●	●				

- can be used with that substrate

Substrates	Thermosetting adhesives						
	Urea glues (UF)	Melamine glues	Resorcinol and formaldehyde glues	Phenolic glues	Polyurethane glues	Polyester	Epoxies
Wood	●	●	●	●	●	●	●
Paper with honeycomb structure	●	●	●	●	●	●	●
Plastic foam or honeycomb materials: polystyrene					●		●
Pvc ²					●		●
Phenol-formaldehyde	●	●	●	●	●	●	●
Polyurethanes					●	●	●
Metal, in the form of sheets or honeycomb structures			●		●	●	●
Mineral substrates in sheets or plaster-based foams	●						
Concrete					●	●	●
Aerated concrete					●	●	●
Glass foam					●	●	●

8.8 Bonding

For best results and to prevent the risk of undulations, surface distortions (or blisters) and cracking, certain strategies are helpful.

- Pre-condition the laminate in temperature and humidity conditions similar to those where it will be installed.
- Avoid the use of, especially hand-applied, contact adhesives if the panel is to be installed in rather humid areas.
- Use contact adhesives only if the panel is no more than 600mm wide, applying it evenly to both surfaces in not too thick a layer.
- Cut the long side of the composite panel in the lengthwise direction of the laminate sheet, parallel to the direction of sanding.

Disclaimer

The disclaimer that follows is a summary of the applicable full disclaimer (which can be found on arpaindustriale.com). The information provided by Arpa Industriale S.p.A. ("Arpa") in this document is solely indicative. Arpa is unable to warrant the accuracy and completeness of this information. No rights can be derived from the information provided; the use of the information is at the other party's risk and responsibility. This document does not guarantee any properties of Arpa's products. Arpa does not warrant that the information in this document is suitable for the purpose for which it is consulted by the other party. The document does not contain any design, structural calculation, estimate or other warranty or representation that customers and third parties may rely on. Colours used in Arpa's communications (including but not limited to printed matter) and in samples of Arpa's products may differ from the colours of the Arpa's products to be supplied. Arpa's products and samples are produced within the specified colour tolerances and the colours (of production batches) may differ, even if the same colour is used. The viewing angle also influences the colour perception. Customers and third parties must have a professional adviser inform them about (the suitability of) the Arpa's products for all desired applications and about applicable laws and regulations. Arpa reserves the right to change (the specifications for) its products without prior notice. To the maximum extent permitted under the applicable law, Arpa is not liable (neither contractual nor non-contractual) for any damage arising from or related to the use of this document, except if and to the extent that such damage is the result of wilful misconduct or gross negligence on the part of Arpa and/or its management. All oral and written statements, offers, quotations, sales, supplies, deliveries and/or agreements and all related activities of Arpa are governed by the General Terms and Conditions of Arpa Industriale S.p.A. All oral and written statements, offers, quotations, sales, supplies, deliveries and/or agreements and all related work of Arpa USA, Inc. ("Arpa USA") are governed by the Arpa USA General Terms and Conditions of Sale. All intellectual property rights and other rights regarding the content of this document (including logos, text and photographs) are owned by Arpa and/or its licensors.

Arpa Industriale S.p.A.

Via Piumati, 91
12042 Bra (CN) – Italy
Tel. +39 0172 436111
Fax +39 0172 431151
E-mail: arpa@arpaindustriale.com
export@arpaindustriale.com

Arpa Industriale Iberica S.L.U.

Calle Ribera, 5
08003 Barcelona – Spain
Tel. +34 932 687 061
Fax +34 931 163 300
E-mail: arpaiberica@arpaindustriale.com

Arpa France S.A.R.L.

50, Impasse de la Balme
69805 SAINT PRIEST - CEDEX - France
Tel. +33 (0)4 78 90 00 23
Fax +33 (0)4 78 90 64 66
E-mail: arpafrance@arpaindustriale.com

Arpa Germany

E-mail: arpadeutschland@arpaindustriale.com

Arpa Nederland B.V.

Nieuw Matheneserstraat 69
3113 AE SCHIEDAM - The Netherlands
Tel. +31 (0)10 2857315
Fax +31 (0)10 2857331
E-mail: arpanl@arpaindustriale.com

Arpa UK Ltd

Block 3, Parkhall Business Village,
Park Hall Road, Longton
Stoke-On-Trent ST3 5XA – Great Britain
Tel. +44 (0)1782 332 368
Fax +44 (0)1782 331 876
E-mail: arpauk@arpaindustriale.com

Arpa USA

62, Greene Street
NEW YORK, NY 10012 – USA
Tel. +1 212 334 6888
E-mail: arpausa@arpaindustriale.com